

Miscelatore monocomando incasso con attacco doccia incluso con doccia e flessibile - Cromato

TARA

ST 050 205 6660



Compatibile con: TARA, META

- piastra di copertura Ø 78 mm
 - Flessibile doccia in metallo 1750mm con protezione antitorsione integrata
 - asta da parete con supporto scorrevole
 - A tre o regolazioni: COMPACT RAIN, COMPACT SOFT FLOW, COMPACT AQUAPRESSURE FLOW, portata max. l/min (a 3 bar)
 - Soffione Ø 100mm
- Sistema di sicurezza antiriflusso.**

	Cromato	ST 050 205 6660-00
	Platinato spazzolato	ST 050 205 6660-06
	Platinato	ST 050 205 6660-08
	Dark Chrome	ST 050 205 6660-19
	Ottone spazzolato (Oro 23k)	ST 050 205 6660-28
	Nero opaco	ST 050 205 6660-33
	Bronzo spazzolato	ST 050 205 6660-42
	Champagne spazzolato (Oro 22k)	ST 050 205 6660-46
	Champagne (Oro 22k)	ST 050 205 6660-47
	Cromo spazzolato	ST 050 205 6660-93
	Dark Platinum spazzolato	ST 050 205 6660-99

Componenti singoli di questo set

Per questo set sono necessari i seguenti componenti

1x 28 018 979-00



1x 36 013 660-00



Miscelatore monocomando incasso con attacco doccia incluso con doccia e flessibile - Cromato

TARA

















ST 050 205 6660



- A tre o regolazioni: COMPACT RAIN, COMPACT SOFT FLOW, COMPACT AQUAPRESSURE FLOW, portata max. 15 l/min (a 3 bar)
- con sistema anticalcare
- Soffione Ø 100mm
- ingresso 1/2"
- Funzione a partire da: 7 l/min

Sistema di sicurezza antiriflusso.

Compatibile con: IMO, LULU, MADISON, MEM, TARA, CL.1, LISSÉ, VAIA, META, CYO

	Cromato	28 018 979-00
	Cromato	28 018 979-00 0010
	Platinato spazzolato	28 018 979-06
	Platinato spazzolato	28 018 979-06 0010
	Platinato	28 018 979-08
	Platinato	28 018 979-08 0010
	Dark Brass matt	28 018 979-16 0010
	Dark Bronze matt	28 018 979-17 0010
	Dark Chrome	28 018 979-19
	Dark Chrome	28 018 979-19 0010
	Light Gold	28 018 979-26 0010
	Light Gold	28 018 979-26
	Light Gold spazzolato	28 018 979-27 0010
	Light Gold spazzolato	28 018 979-27
	Ottone spazzolato (Oro 23k)	28 018 979-28
	Ottone spazzolato (Oro 23k)	28 018 979-28 0010
	Nero opaco	28 018 979-33
	Nero opaco	28 018 979-33 0010
	Bronzo spazzolato	28 018 979-42
	Bronzo spazzolato	28 018 979-42 0010
	Champagne spazzolato (Oro 22k)	28 018 979-46
	Champagne spazzolato (Oro 22k)	28 018 979-46 0010
	Champagne (Oro 22k)	28 018 979-47
	Champagne (Oro 22k)	28 018 979-47 0010
	Cromo spazzolato	28 018 979-93
	Cromo spazzolato	28 018 979-93 0010
	Dark Platinum spazzolato	28 018 979-99
	Dark Platinum spazzolato	28 018 979-99 0010



Miscelatore monocomando incasso con attacco doccia incluso con doccetta e flessibile - Cromato

TARA

ST 050 205 6660

ST 050 205 6660
mm [inches]



Diagramma di portata

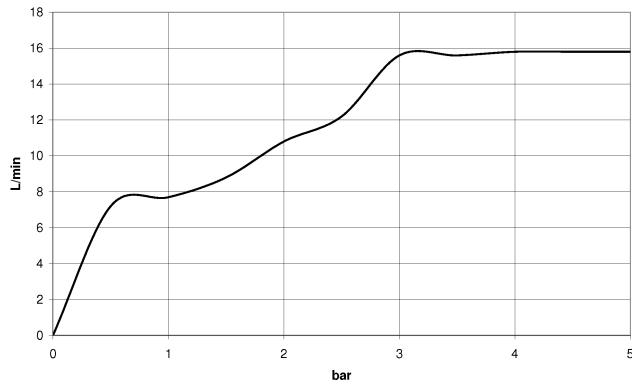

Certificati

LGA_29984.

DVGW_DW-
6517DN0129.

WRAS_2210003.

ST 050 205 6660

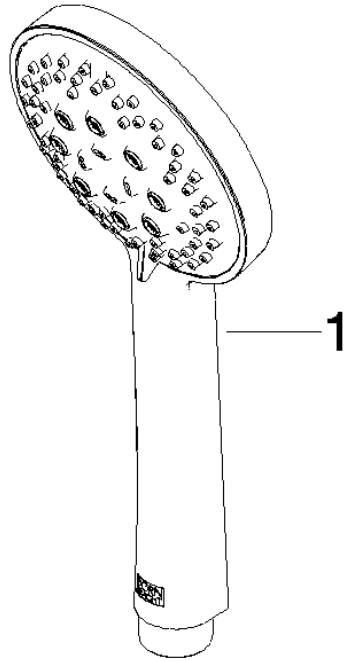

Elenco delle parti di ricambio

N.	Codice articolo	Denominazione	Quantità necessaria	Tempo di produzione
1	09 23 01 039 90	setaccio	1	2

Miscelatore monocomando incasso con attacco doccia incluso con doccetta e flessibile - Cromato

TARA

ST 050 205 6660



Compatibile con: TARA, META

- piastra di copertura Ø 78 mm
- Flessibile doccetta in metallo 1750mm con protezione antitorsione integrata
- asta da parete con supporto scorrevole

Questo articolo non include la doccetta!

Sistema di sicurezza antiriflusso.

L'articolo non può essere allungato, attenzione alla profondità d'incasso!

Questo articolo non include la doccetta!

Sistema di sicurezza antiriflusso.

L'articolo non può essere allungato, attenzione alla profondità d'incasso!

	Cromato	36 013 660-00
	Platinato spazzolato	36 013 660-06
	Platinato	36 013 660-08
	Dark Chrome	36 013 660-19
	Light Gold spazzolato	36 013 660-27
	Ottone spazzolato (Oro 23k)	36 013 660-28
	Nero opaco	36 013 660-33
	Champagne spazzolato (Oro 22k)	36 013 660-46
	Champagne (Oro 22k)	36 013 660-47
	Cromo spazzolato	36 013 660-93
	Dark Platinum spazzolato	36 013 660-99

Prodotti complementari necessari

	Fissaggio a muro da incasso - ●Profondità d'incasso max. 103 mm ●profondità d'incasso min. 78 mm	35 003 970 90
--	---	---------------

Prodotti complementari necessari

	Doccetta - Cromato	28 016 979-00
--	---------------------------	---------------

Prodotti complementari necessari

	Doccetta - Cromato	28 012 979-00
--	---------------------------	---------------

Prodotti complementari necessari

	Doccetta FlowReduce - Cromato	28 016 979-00 0010
--	--------------------------------------	-----------------------

Prodotti complementari necessari

	Doccetta FlowReduce - Cromato	28 012 979-00 0010
--	--------------------------------------	-----------------------

Prodotti complementari necessari

	Doccetta - Cromato	28 017 979-00
--	---------------------------	---------------

Prodotti complementari necessari

	Doccetta - Cromato	28 018 979-00
--	---------------------------	---------------

Prodotti complementari necessari

	Doccetta FlowReduce - Cromato	28 018 979-00 0010
--	--------------------------------------	-----------------------



Miscelatore monocomando incasso con attacco doccia incluso con doccetta e flessibile - Cromato

TARA

ST 050 205 6660

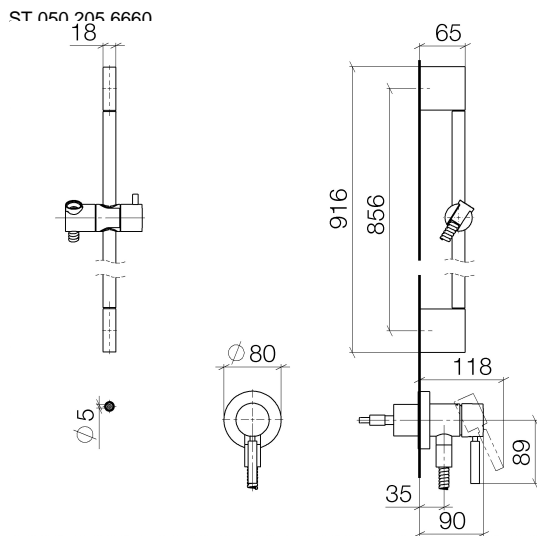

Certificati

Belgaqua_21-025- WRAS_2011027. LGA_29569.
27_1.

ST 050 205 6660

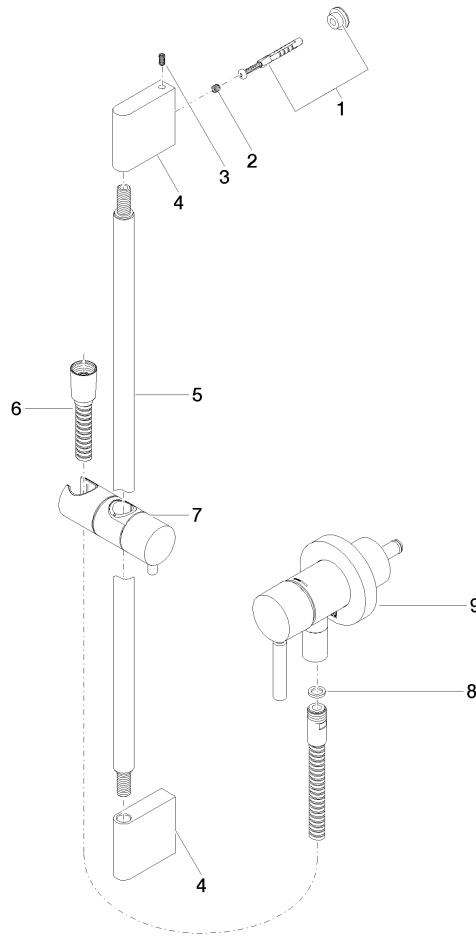

Elenco delle parti di ricambio

N.	Codice articolo	Denominazione	Quantità necessaria	Tempo di produzione
1	05 17 20 726 02 90	set di fissaggio	1	2
2	09 31 11 049 90	perno	2	2
3	04 31 11 113 00 90	perno	2	2
4	08 17 97 054-00	sostegno	2	10
5	90 28 22 597 00-00	sostegno	1	10
6	28 322 970-00	Flessibile metallico per doccetta 1/2" x 3/8" x 1750 mm - Cromato	1	2
7	12 580 970-00	Supporto scorrevole - Cromato	1	10
8	90 14 20 026 00 90	guarnizione	1	2
9	36 045 660-00	Miscelatore monocomando incasso con piastra di copertura con attacco doccia incluso - Cromato	1	10